

Lavavasos y lavaplatos industriales



Lavavasos y lavaplatos industriales



Indice

LV 335	3
LV 440 - LV 440 P	4
LP 550 - LP 550 P	5
CU 850	6
Cestas y accesorios	7



LV 335

Modelo	Cod.
LV 335	M116996

Equipamiento	Cod.
 n. 2	PG115970
 n. 1	780139

Optional	Cod.
Bomba de desagüe	PG116685
Dosificador de detergente	999347

Datos técnicos

Dimensiones	cm	40.1x49x59.5
Altura puerta	cm	26
Altura máxima plato	cm	-
Altura máxima vaso	cm	25
Ciclo de lavado	sec.	120
Cesta	cm	35x35
Consumo de agua	L/ciclo	2.2
Bomba propulsora	kW	0.15
	L	7
Cuba	kW	0.6
	°C	60
	L	2.6
Calderín	kW	2.6
	°C	65
	V/Hz/Ph	230/50/1
Potencia instalada	kW	3.5
Dosificador peristaltico de abrillantador		✓

Diagrama de instalación

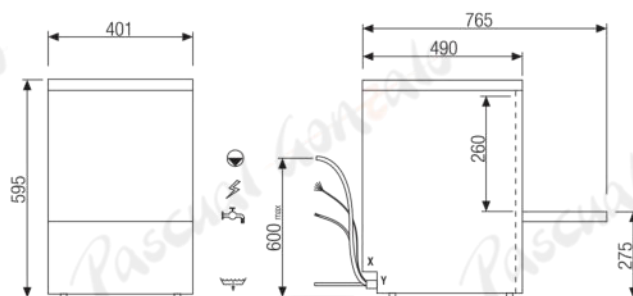



X: 62 mm - Y: 50 mm

LV 440 - LV 440 P



Modelo	Cod.
LV 440	M116997
LV 440 P*	M117296

* version con bomba de desagüe

Equipamiento	Cod.
 n. 2	PG114685
 n. 1	780139

Optional	Cod.
Bomba de desagüe	PG116685
Dosificador de detergente	999347

Datos técnicos		
Dimensiones	cm	43.6x53.5x67
Altura puerta	cm	32
Altura máxima plato	cm	30
Altura máxima vaso	cm	30
Ciclo de lavado	sec.	120
Cesta	cm	39x39
Consumo de agua	L/ciclo	2.2
Bomba propulsora	kW	0.2
	L	8
Cuba	kW	0.6
	°C	60
	L	2.6
Calderín	kW	2.6
	°C	65
Potencia instalada	V/Hz/Ph	230/50/1
	kW	3.5
Dosificador peristáltico de abrillantador		✓

Diagrama de instalación

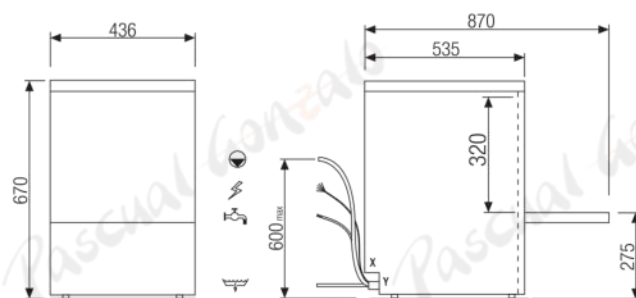

X: 77 mm - Y: 50 mm



LP 550 - LP 550 P

Modelo	Cod.
LP 550	M116998
LP 550 P*	M117297

* version con bomba de desagüe

Equipamiento	Cod.
 n. 1	780131
 n. 1	780132
 n. 1	780139

Optional	Cod.
Bomba de desagüe	PG116965
Dosificador de detergente	999347

Datos técnicos

Dimensiones	cm	57.5x60.5x82
Altura puerta	cm	36.5
Altura máxima plato	cm	36.5
Altura máxima vaso	cm	32.5
Ciclo de lavado	sec.	90 - 150
Cesta	cm	50x50
Consumo de agua	L/ciclo	2.6
Bomba propulsora	kW	0.47
	L	20
Cuba	kW	2.1
	°C	60
	L	6
Calderín	kW	3
	°C	80
	V/Hz/Ph	230/50/1
Potencia instalada	kW	3.5
Dosificador peristáltico de abrillantador		✓

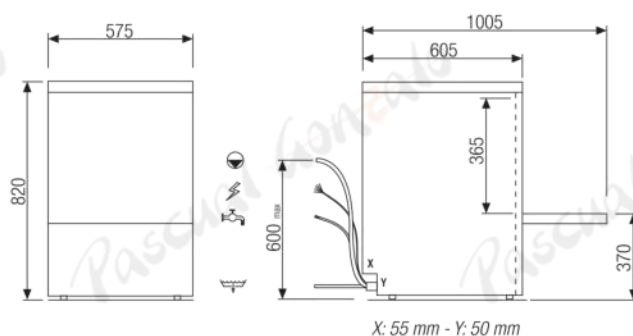

Diagrama de instalación



CU 850



Modelo	Cod.
CU 850	M117295

Equipamiento		Cod.
	n. 1	780131
	n. 1	780132
	n. 1	780139

Optional	Cod.	€
Bomba de desagüe	PG116965	
Dosificador de detergente	41954	

Datos técnicos		
Dimensiones	cm	63.4x74.4x152.9
Altura puerta	cm	45
Altura máxima plato	cm	44
Altura máxima vaso	cm	42.5
Ciclo de lavado	sec.	90 - 150
Cesta	cm	50x50
Consumo de agua	L/ciclo	2.6
Bomba propulsora	kW	0.47
	L	15
Cuba	kW	2.1
	°C	60
	L	6
Calderín	kW	8
	°C	80
Potencia instalada	V/Hz/Ph	400/50/3N
	kW	8.5
Dosificador peristáltico de abrillantador		✓

Diagrama de instalación

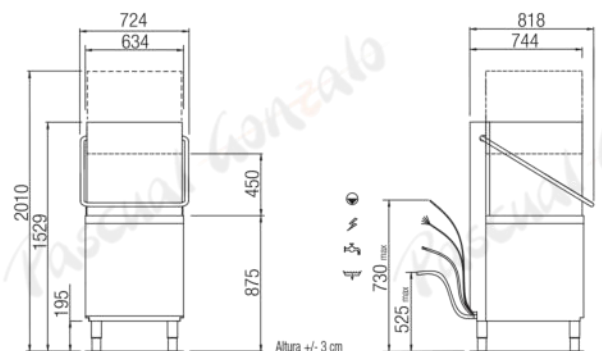

Cestas y accesorios

Mod.	Dim. (cm)	Cod.
	Cesta vasos	35x35 PG115970
	Cesta vasos	39x39 PG114685
	Cesta vasos	50x50 780132
	Cesta platos	50x50 780131
	Insertador para 13 platitos	31x9 712020
	Insertador para platos para cesta PG114685	 780140
	Contenedor de cubiertos	11x11x14 780139
	Soporte cerrado (para machina con cesta 50x50)	60x60x38 798006



Tel. 963 809 682 | Fax. 963 802 027 | WhatsApp 618 438 282

c/Doctor Marañón, 14 C.P.46017 Valencia